



**HEADSET
AND HELMET**

INSTRUCTIONS

Thank you for purchasing the Lynx Micro System.

IMPORTANT

The following instructions have been prepared to provide users of the Lynx Micro Communications System with the necessary information to enable safe and correct use.

Please read this booklet carefully and take time to familiarise yourself with your new equipment and its mode of operation before attempting to use it during flight.

CONTENTS

SECTION		PAGE N°
1	INTRODUCTION	1
2	SYSTEM CONFIGURATION	3
3	OPTIMUM OPERATION	5
4	HELMET ASSEMBLY AND FITTING	7
5	CHARGING	9
6	SAFETY IN USE	11

INTRODUCTION

The Lynx Micro System Headset and Helmet have been purposely designed for use in the high-noise environment of open-cockpit aviation where noise attenuation and microphone noise cancellation are primary concerns. The Micro System provides for both clear pilot to co-pilot communication and, when interfaced with a suitable transceiver high quality radio telephony .



Built to exacting standards, the Micro System is designed to offer the user the very latest in technology in a product intended to provide many years of rugged and reliable service.

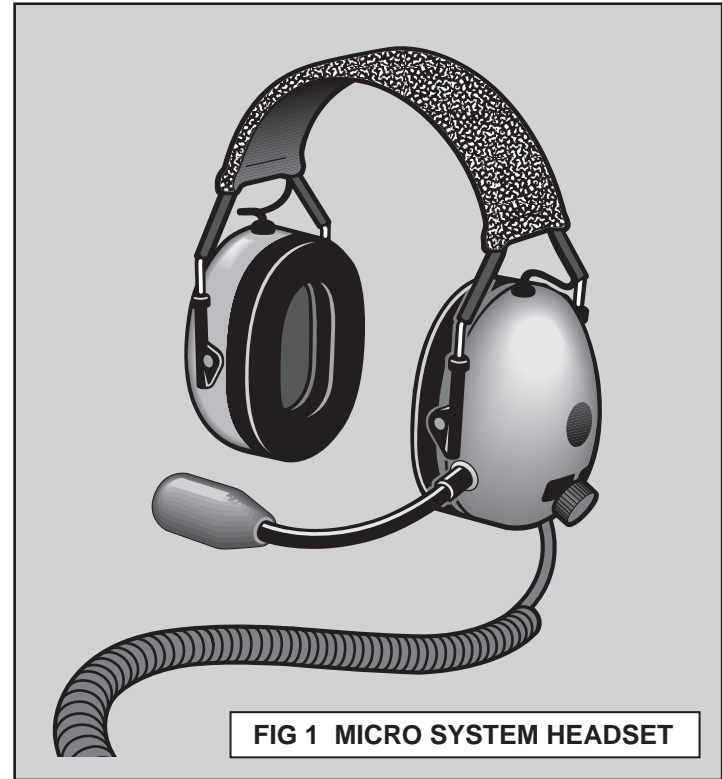

FIG 1 MICRO SYSTEM HEADSET

Micro System Headset

The Micro System Headset is the world's first to incorporate both the electronics and the power supply necessary to enable audio intercommunication. The self-contained headset (fig 1) is manufactured utilising the latest techniques in microcircuitry and the most recent developments in Nickel Metal Hydride battery technology.

Each headset contains a high-specification electret noise-cancelling microphone, a sub-miniature speech processor module, high-efficiency speakers and a series of rechargeable cells. The design and construction of the ear defenders provide noise attenuation and hearing protection in noise levels up to 110 dB(A). The liquid-ring ear seals combine with the adjustable headband to give total comfort over periods of extended use.

Micro System Helmet

The Micro System Helmet (fig 2) is designed to mate with the headset to provide a degree of head protection in the event of an accident. Manufactured from Antracol Polycarbonate, the shell is light and extremely strong. The Styrene inner liner is formed to accommodate the headset and is supplied in a range of sizes to ensure an accurate and comfortable fit. The helmet can be used with either goggles or a visor, to protect the eyes from the elements and small flying objects.

The full-face visor is manufactured from scratch-resistant Lexan Polycarbonate and is securely attached to the helmet shell using machine fasteners and a foam sealing strip.

The Lynx Micro System Helmet is only intended for aviation use and is not approved for any other application.

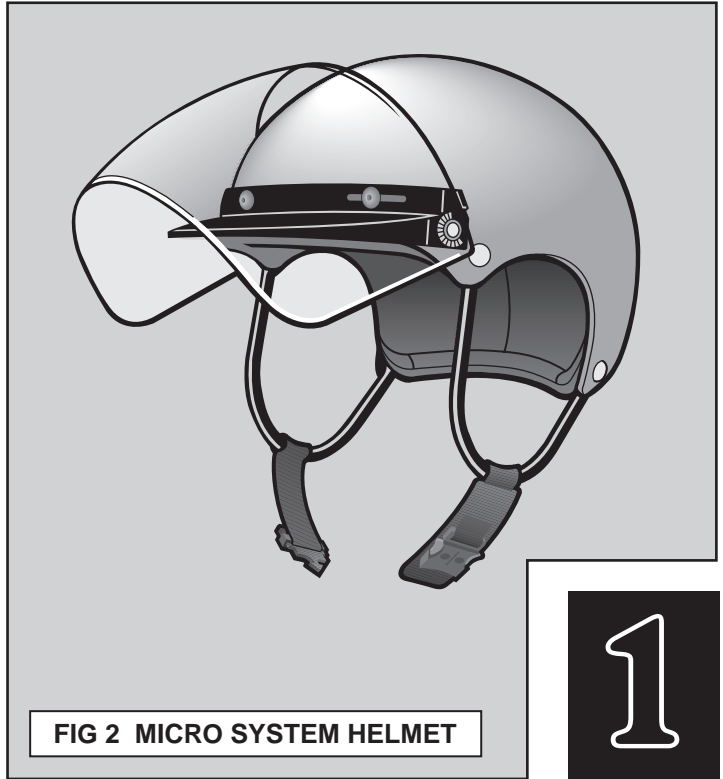

SYSTEM CONFIGURATION

The Lynx Micro System concept is intended to simplify considerably the configuration and operation of intercommunication equipment within the open-cockpit environment. Designed around the self-contained headset assembly, all external extraneous wiring and intercom units have been dispensed with, creating an innovative system of unparalleled convenience.

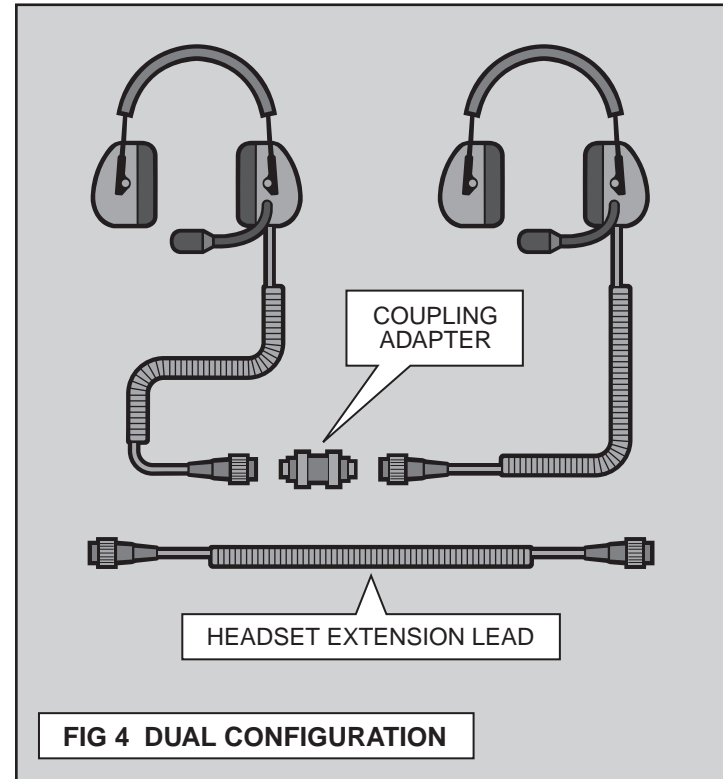
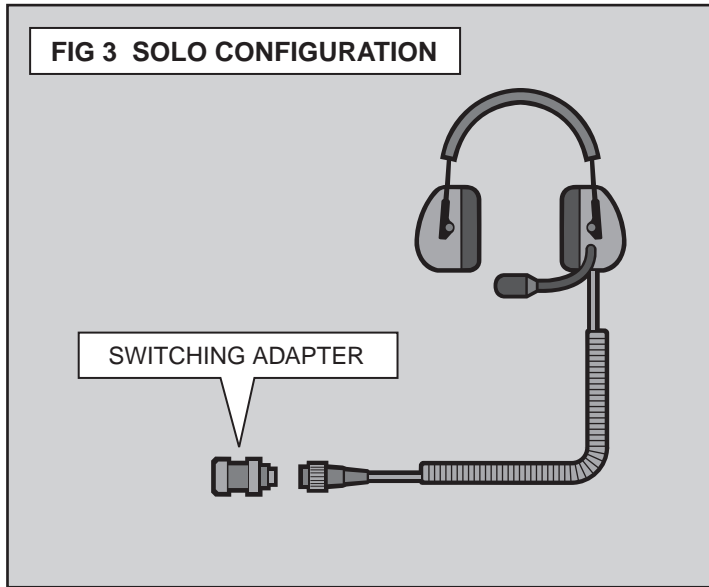

Solo Operation

When using a headset and flying solo, without the use of radio, the single headset can be energised using the switching adapter provided (fig 3). Using the headset in this way allows the level of background noise to be set using the headset volume control and enables the user to monitor some engine noise during flight. Always use the headset in noisy environments even if the intercom or radio facility is not required.

Dual Operation

In the normal mode of operation, without the use of radio, the system configures by simply plugging two headsets together using the coupling adapter provided (fig 4). The headset leads may also be extended, if required, using an optional headset extension lead.

Once connected together, the headsets are automatically switched on: establishing two way communication. Each headset also provides side-tone audio, allowing the user to monitor their own voice and some background noise during use.

Radio Telephony

For radio telephony applications the Micro System Headset can be easily connected to suitable transceivers using a Lynx Radio Interface Unit (fig 5). Several types of Interface are available from Lynx and are supplied with all necessary fittings and connections to match most V.H.F. transceivers manufactured for aviation applications.

Please refer to the individual operating instructions for information on Interface configuration and use.

Note

All interconnections in the Micro System are made using high-quality bayonet-locking connectors. Always remember to use the bayonet locks in safety-critical applications.

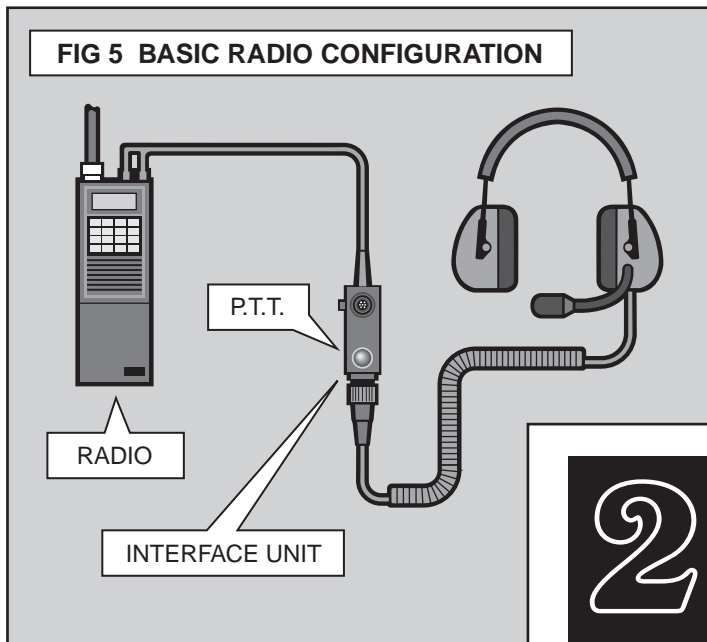

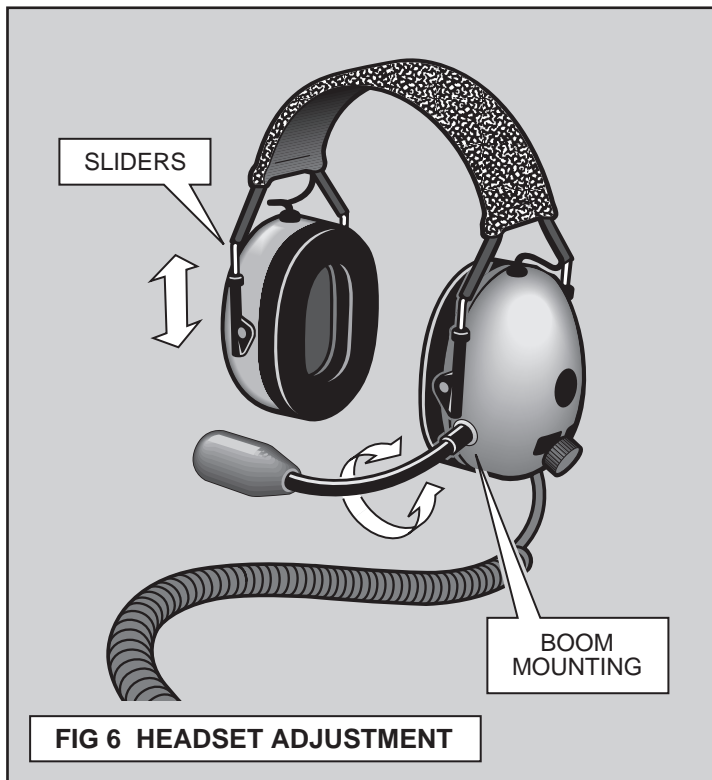

OPTIMUM OPERATION

In order to gain maximum benefit from your Micro System Headsets, and to ensure ease of operation, it is advisable to study the simple techniques described below.

Headset Fitting

The headset headband is adjustable to allow for variations in head shape and size. Adjustment is made possible by the inclusion of sliders at the connection between the headband and the ear defender (fig 6). The simplest means of fitting correctly is to place the headset on the head and then slide the ear defenders downwards until they completely cover the ears. To obtain the best possible noise attenuation, remove as much hair as possible from beneath the ear seals and ensure that the headset is a tight and comfortable fit.

Microphone Technique

The microphone is mounted on the end of a flexible boom arm and is protected from the elements by a foam wind-shield. A flat area on the shield indicates where the sound should enter the microphone and must always face directly towards the mouth (fig 7). For best results the flat area should also be positioned as close as possible to the lips but without actually touching. Once the boom arm has been set in position it may be swung out of the way and returned to the same position by simply rotating it about the boom mounting (fig 6).

Volume Setting

The Micro Headset is fitted with a volume control allowing the speaker output in each headset to be increased or decreased independently

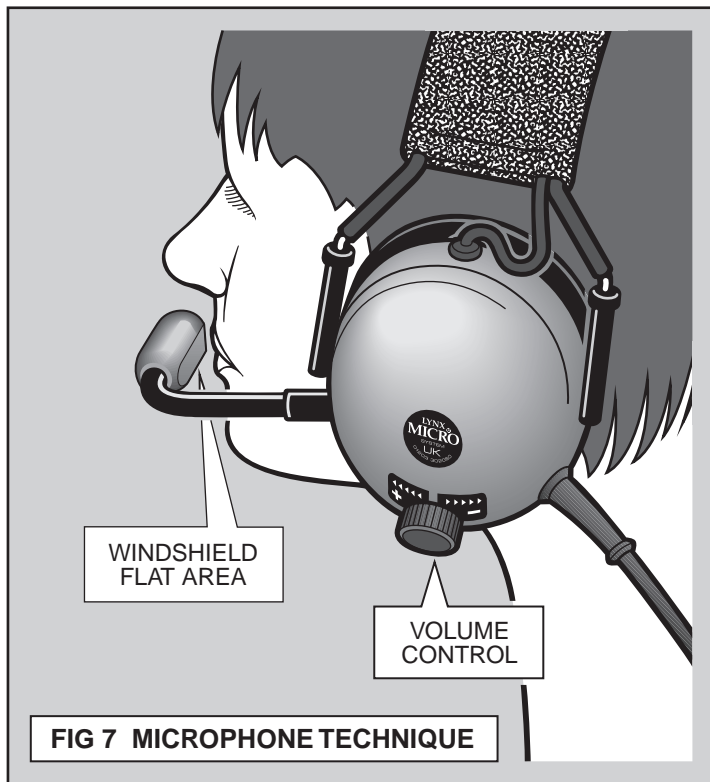

(fig 7). Correct setting of this control is important in order to minimise the amount of extraneous background noise reaching the ears and to compensate for differences in individual hearing sensitivity.

Initial volume adjustment should take place once the headset has been connected and switched on. At this stage the volume should be set to a comfortable level in preparation for making any radio check transmissions and before starting the aircraft engine.

Whilst undertaking radio checks it is important to note that the headset volume control only affects the output of the headset speakers. The level of audio received by radio should be adjusted separately using the transceiver volume control. For more detailed information on radio operation refer to the relevant transceiver operating instructions.

After the aircraft engine has been started the headset volume can be set more accurately by progressively reducing the level until the background noise is almost all cancelled out. Always remember to set the volume at a level where the engine noise is still slightly audible as often the sound of the engine is the first indication of impending problems in this area.

Battery Conservation

In order to conserve battery power, disconnect the headsets after use. Always recharge your headsets after each day's flying and never store a headset with the battery partially discharged. For detailed information on recharging Micro System headsets, refer to Section 5 on page 9 of this booklet.



FIG 8 HELMET ASSEMBLY

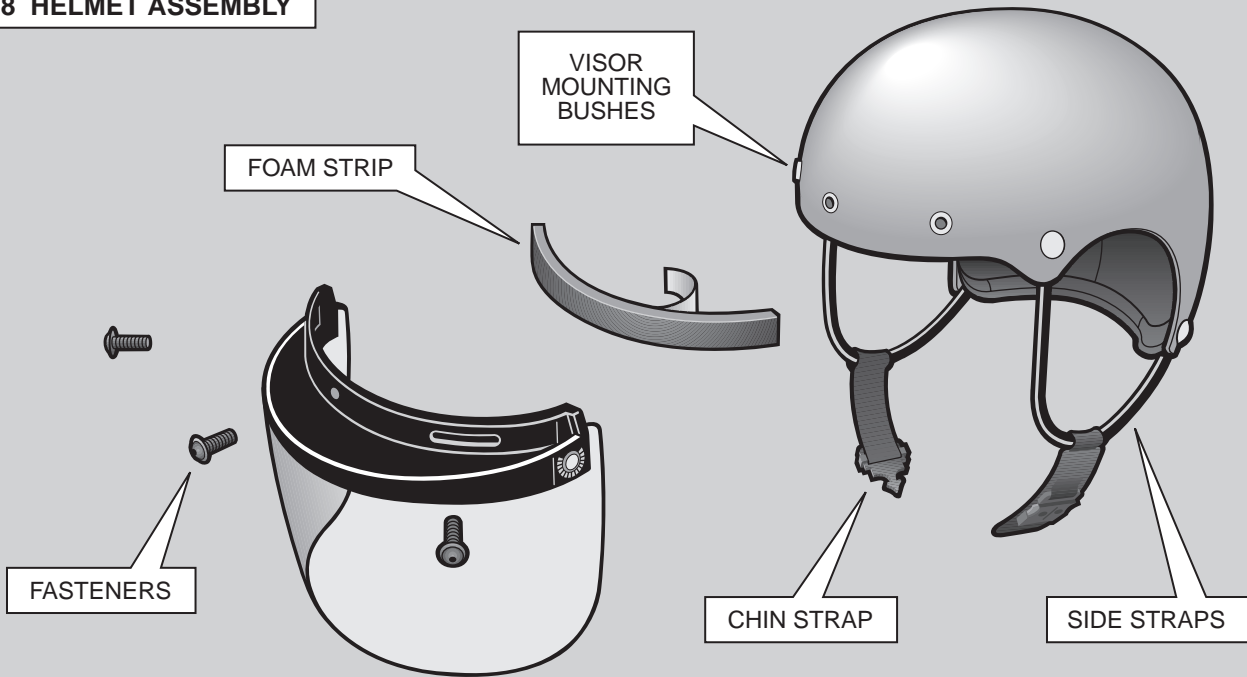

HELMET ASSEMBLY AND FITTING

The Lynx Helmet is designed specifically for aviation use and is intended to be used only in conjunction with a Lynx Headset. The outer shell and inner liner are formed to accept the shape of the headset and combine with it to provide an integrated assembly.

Helmet Size

Lynx Helmets are manufactured in a range of sizes in order to provide individuals with comfortable and securely-fitting head protection. If you are in any way concerned as to the suitability of the size of helmet supplied to you, do not hesitate to contact your supplier for advice.

Visor

The Lynx Helmet can be used with or without a visor attached. For open-cockpit applications however, the fitting of a visor is recommended (fig 8). The visor is supplied with a foam sealing strip, fixing screws and a hexagon drive key.

To fit the visor, first remove the backing from the self-adhesive sealing strip and apply the strip to the helmet in such a way as to cover the three visor mounting bushes. Once in place, make a hole through the strip into each bush in order to help locate the fixing screws. Position the visor in relation to the bushes and, taking care not to cross-thread the screws, fasten securely in place.

Helmet Fitting

The helmet should be fitted after the headset is comfortably in place on the head. Raise the visor and hold the helmet using both hands to grip the side straps. With one half of the chin strap in the palm of each

hand lift the helmet above the head and lower it over the headset by pulling the side straps slightly outwards to clear the ear defenders.

The helmet liner is relieved inside to accommodate the headset headband and it is important to align these two features before fastening the chin strap. It is also important to make sure that the helmet is positioned on the head so that it fully protects the forehead; do not place the helmet too far to the back of the head.

The chin strap should be adjusted to fit the helmet to each individual user. Always make sure that the chin strap is correctly adjusted and securely fastened before use (fig 9).

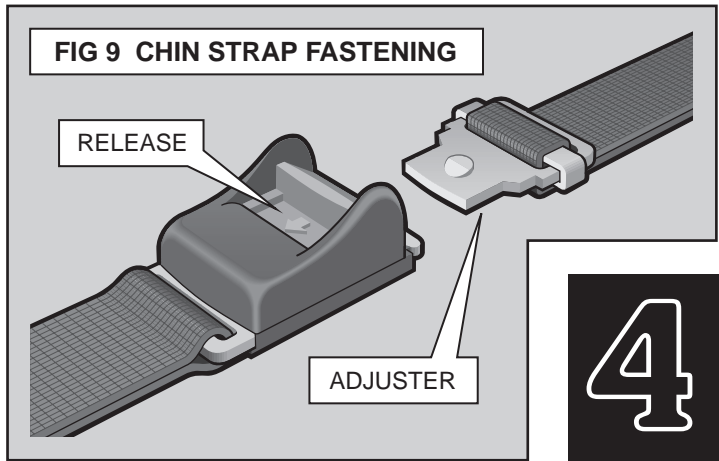

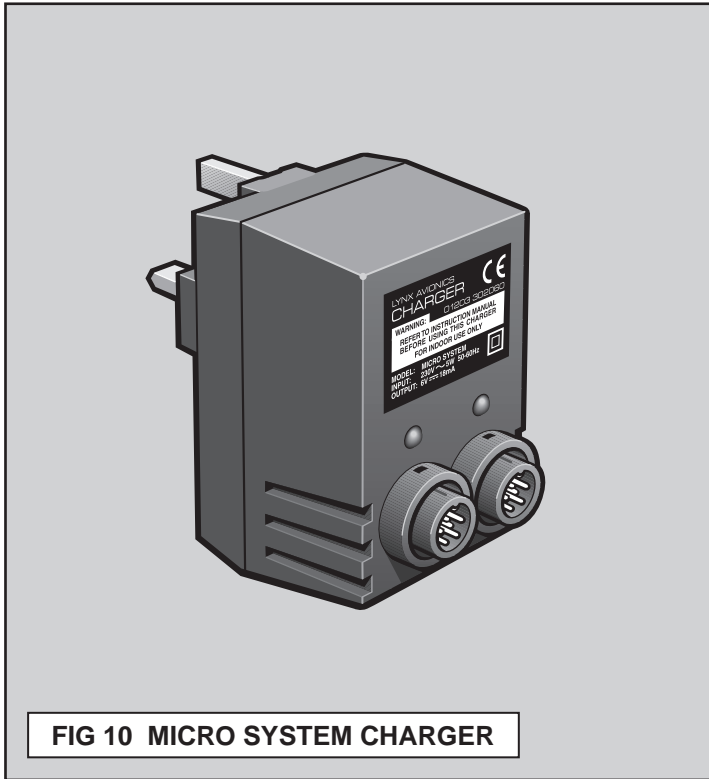

FIG 10 MICRO SYSTEM CHARGER

CHARGING

The Nickel Metal Hydride battery built into the headset provides for a minimum of 50 hours continuous use when fully charged. To obtain the optimum life from the battery it is necessary to follow some simple charging instructions.

Normal Charging

To charge a headset using the Micro System Charger (fig 10), plug the headset into the front of the charger then plug the charger into a domestic wall socket (fig 11). The charger will accept one or two headsets and provides a full charge in 16 hours.

Charging lights are provided on the front of the charger which indicate when a headset is connected and charging. The charging lights only confirm that the charger is working and do not indicate when the headset is fully charged.

Do not leave the headsets on charge continuously for more than 48 hours, as this may damage the headset batteries.

Initial Charge

When charging a new headset for the first time leave the headset on charge for at least 24 hours. This conditions the battery correctly and prolongs battery life.

Optimum Charging

Fully charged Micro System headsets will provide communication for a minimum of 50 hours. Approximately one hour before the batteries are completely discharged, the headset sound begins to distort as an indication that the power is about to run out.

During normal use, headsets will only become partially discharged each day. The headsets should, however, be recharged after each use and stored in a fully charged condition. Headsets that are recharged, and stored in this way, are much less likely to run flat during subsequent use. Never store a completely discharged headset for any length of time, as this will damage the batteries.

The headset batteries do not suffer from memory effect and it is not necessary to completely discharge a headset before recharging.

The battery built into each headset is manufactured using the very latest materials and technology available. Each headset is designed to accept a full recharge at least one thousand times and, if correctly maintained, will provide many years of reliable service.

Warning

The Micro System Charger is only intended for use with Micro System headsets and should not be used for any other application.

Never attempt to charge Micro System headsets using any other battery charger. Incorrect charging can damage both the charger and the headsets and may cause a fire.

Never use the charger in an explosive atmosphere. Connecting the charger to the mains supply, and connecting the headsets to the charger, can produce sparks which may ignite flammable gases.

Never expose the charger to rain or moisture. The charger is not waterproof and is only intended to be used indoors.

The charger contains live parts, at mains voltage, and should not be dismantled. If your charger is damaged in any way or for any reason becomes unserviceable, please contact Lynx Avionics for advice.

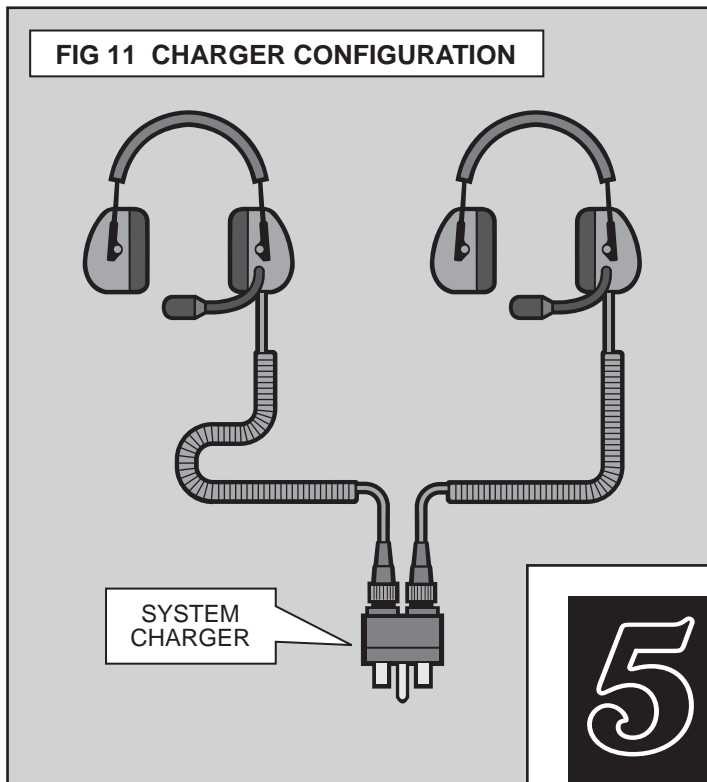

SAFETY IN USE

The Lynx Micro System is intended to provide the pilot with both hearing and head protection. The following points on safety are included here as a guide to the safe and correct method of use.

Cable Routing

Always check before flight that the headset leads and other cables do not interfere with any of the flying controls especially the hand throttle, control column or any of the various control linkages.

When flying solo, using a headset which is not connected to a radio interface unit, it is particularly important to make sure that the headset lead is securely stowed away inside your flying suit.

Be aware at all times that a snagged cable may restrict the freedom of movement of the user as well as the controls of the machine.

Bayonet Locking

The connectors fitted to the headsets enable the leads to be locked together during flight (fig 12). Always utilise the bayonet-locks to prevent accidental separation and always check that they are engaged before use.

Headset Care

The headset should be fitted, adjusted and maintained in strict accordance with the instructions in this booklet. If these recommendations are not adhered to, the hearing protection afforded by the headset may be impaired.

Micro System headsets should not be stored in temperatures exceeding 40°C (104°F) and they should not be left in direct sunlight

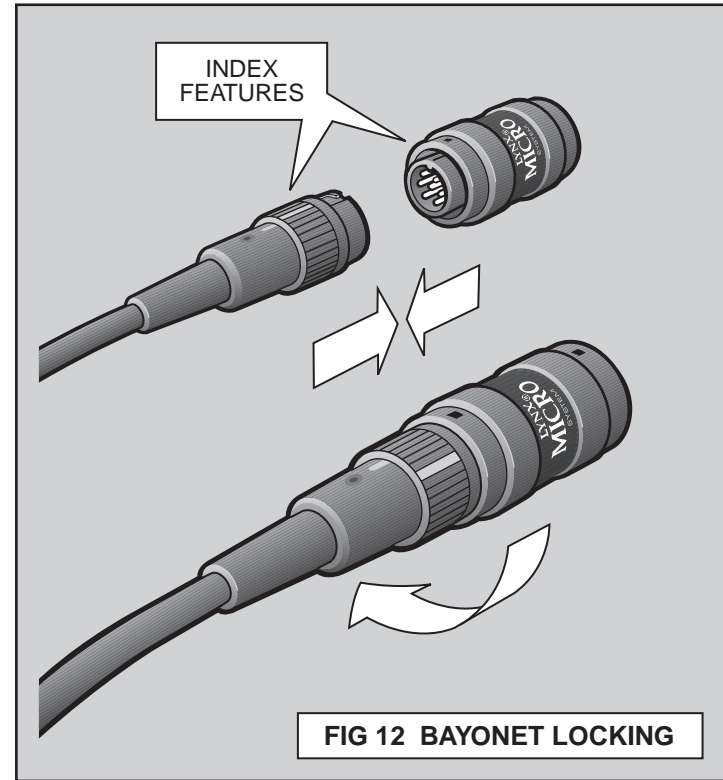

for any period of time. Subjecting the headset to temperatures above 40°C may damage the plastic component parts and, in particular, the liquid-ring ear seals.

The headset and, in particular, the ear seals may become damaged with use and they should be checked at frequent intervals for cracks or noise leakage. Replacement ear seals and fitting instructions are available from Lynx Avionics.

The headset is made from Acrylonitrile Butadiene Styrene and Polyvinyl Chloride, both these substances may be severely affected by the application of paint, adhesive stickers, cleaning fluids and other solvents. Use only a damp cloth and mild detergent to clean a headset and do not immerse the headset in water; for more detailed information on this subject contact Lynx Avionics.

Noise Attenuation

To provide full hearing protection, the headset should be worn at all times in noisy environments. The headset is of the ear-defender type and is designed to prevent as much external noise as possible from reaching the ears. Always remember that, when the headset is worn but not switched on, the unit prevents normal hearing to the extent that verbal instructions or warnings may be inaudible.

Helmet Care

The Micro System Helmet is made to absorb some of the energy of an impact by partial destruction of its component parts. If a helmet is subject to a violent impact during use, or receives similar abuse, it should be discarded even though damage may not be apparent.

The helmet shell is manufactured from Polycarbonate and the helmet liner from Polystyrene, both these substances may be severely affected by the application of paint, adhesive stickers, cleaning fluids and other solvents. Use warm water and mild detergent to clean a helmet and only apply stickers as supplied by Lynx Avionics.

Visor Care

The visors supplied for fitting to Lynx Micro System Helmets are not guaranteed shatterproof and are only intended to protect the face and eyes from the elements and small flying objects.

The visor is manufactured from Lexan Polycarbonate and can be severely damaged by the application of paint, adhesive stickers, cleaning fluids and other solvents. Use only warm water and mild detergent to clean the visor and a soft cloth to wipe it dry.

Care should be taken when using a helmet fitted with a visor, and looking over the shoulder in high wind speeds, as it is possible that a visor may lift unexpectedly due to wind pressure.

If a visor is damaged, or begins to show signs of wear, it should be replaced immediately.

Damaged Equipment

If your Lynx communications equipment is damaged in any way or for any reason becomes unserviceable, please contact Lynx Avionics for advice.

MMIII

© Copyright Lynx Avionics All Rights Reserved



